

HX-112A-1

Installation instructions

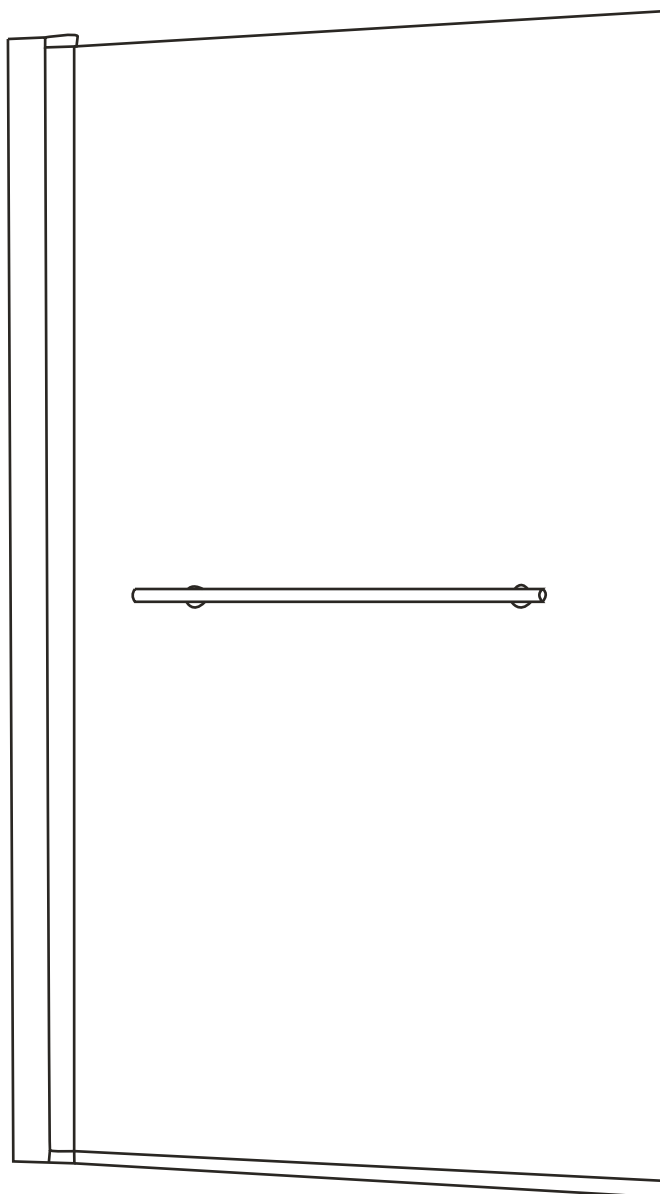

SIZE:85*140 CM



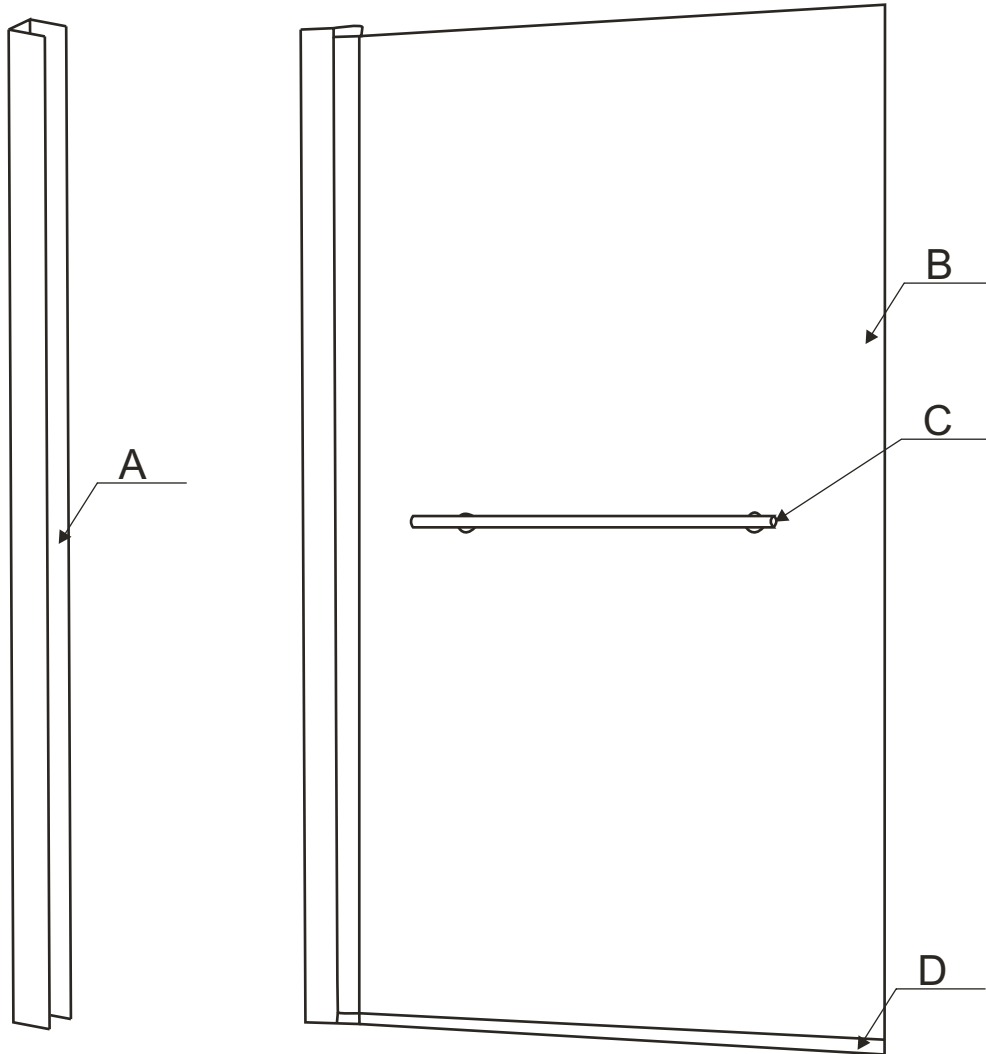

HX-112A-1

Installation instructions



Ref	Description	Qty
A	WALL PROFILE	1
B	SIDE PANEL	1
C	HANDLE	1
D	VERTICAL SEAL FOR FIXED GLASS	1

Fixing kit includes

Ref	Description	Illustration	Qty
A2	green expandable wall plug		4
B2	stainless steel screws: 4*25		4
C2	stainless steel screws: 4*10		3
D2	Drill beat head 3mm		1

HX-112A-1

Installation instructions

TOOLS REQUIRED(NOT SUPPLIED)

when you're ready to start,make sure that you have the following tools to hand,plenty of space and a clean dry area for assembly.

Two people are needed. Please note:although these instructions are comprehensive,We always recommend that a technically competent installer should undertake installation.

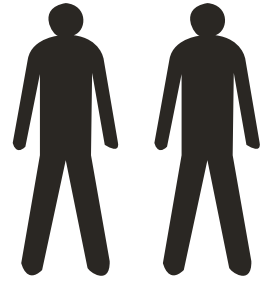

Drill beat head
5.5mm

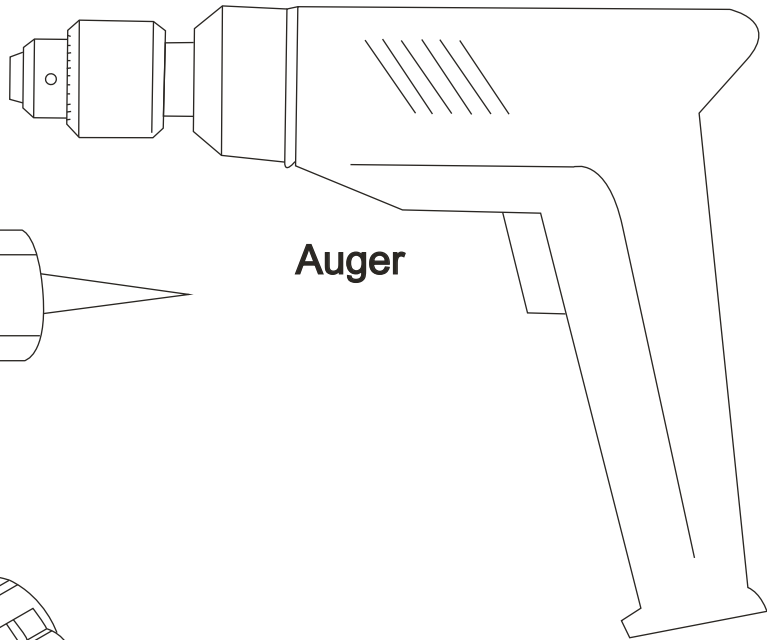

Auger

Sanitary Silicone

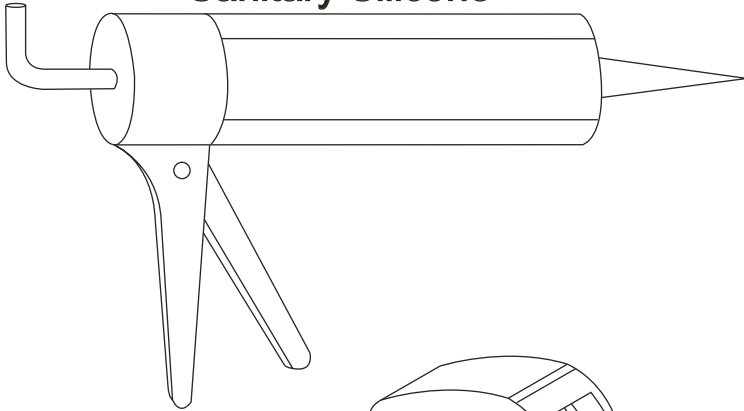

Tape measure

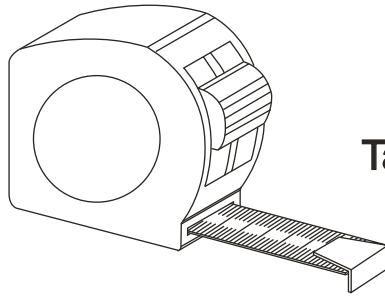

Pencil

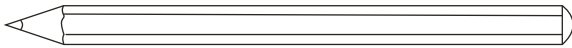

Magnetic crosshead screwdriver

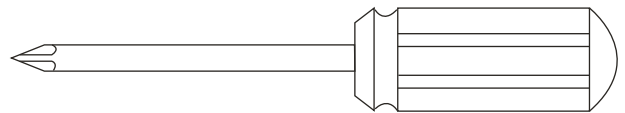

Level

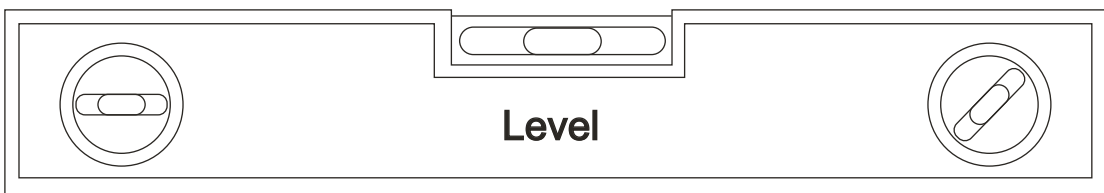

HX-112A-1

Installation instructions

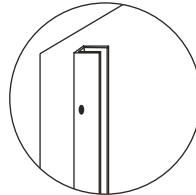
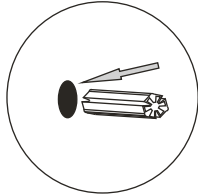
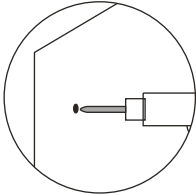
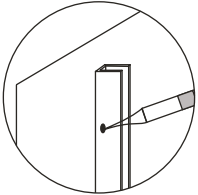
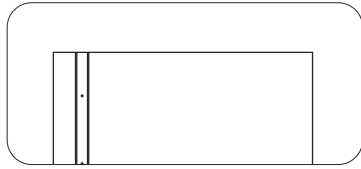

Using a Spirit level, draw a horizontal line from top to bottom. Hold the WALL PROFILE (A) parallel with the penciled mark on the wall and mark the pre-drilled holes inside the Aluminum Frame.

Using a 5.5mm Ceramic Tile Drill bit, drill carefully through the Tile only, and replace the Ceramic Tile drill with a 5.5mm Masonry Drill bit.

Drill 30mm deep into the wall, attempt not to use the Hammer-action on your drill as it may cause the Ceramic Tile to crack or break.

Insert wall plugs (A2) into hole and tap in until flush with tiles.

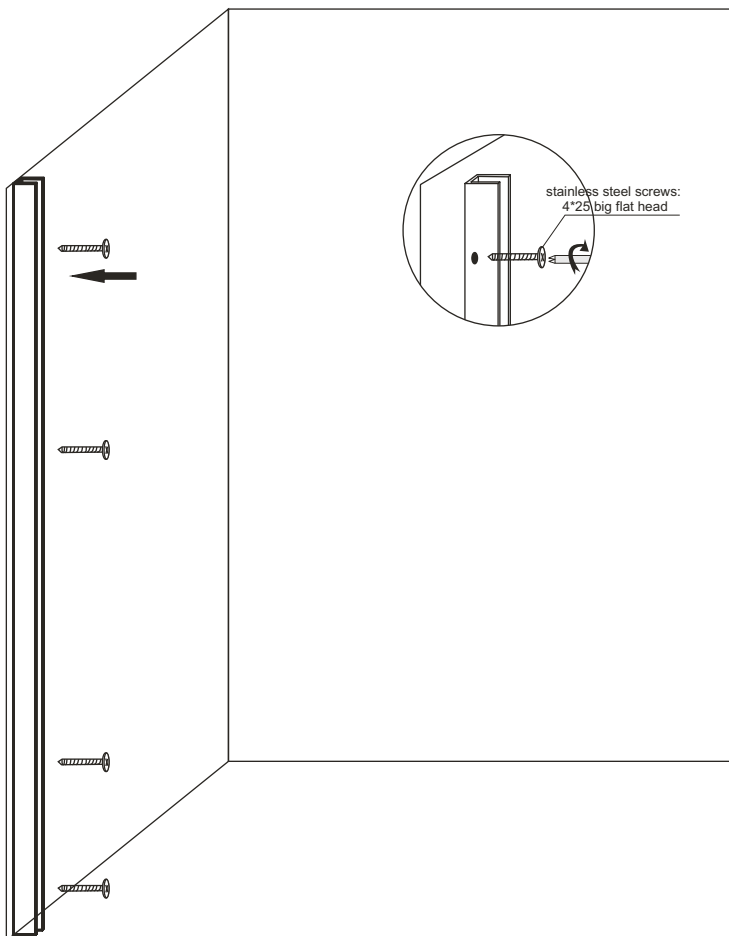

Using a Phillips Screwdriver, secure the WALL PROFILE (A) to the wall with the screws (B2) provided. It may be a good idea to check by use of the spirit level if work is plumb.

Repeat the same steps on opposite wall.

HX-112A-1

Installation instructions

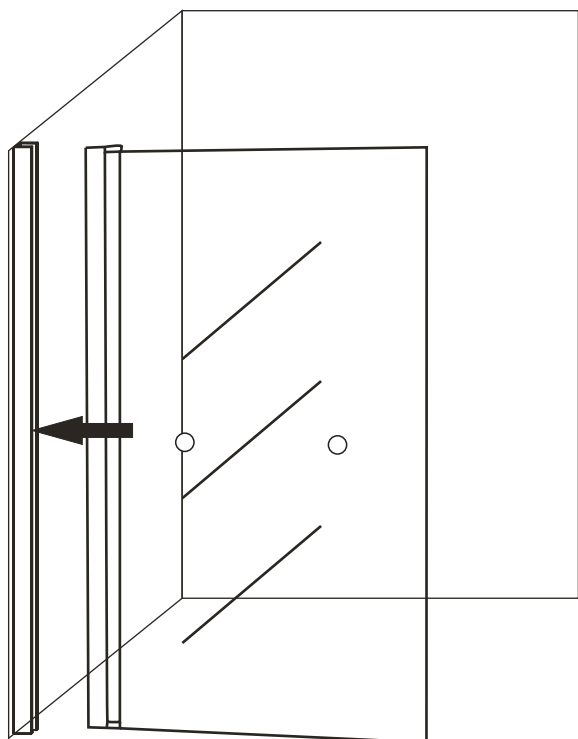

SIDE PANEL(B) fixed to the WALL PROFILE (A).

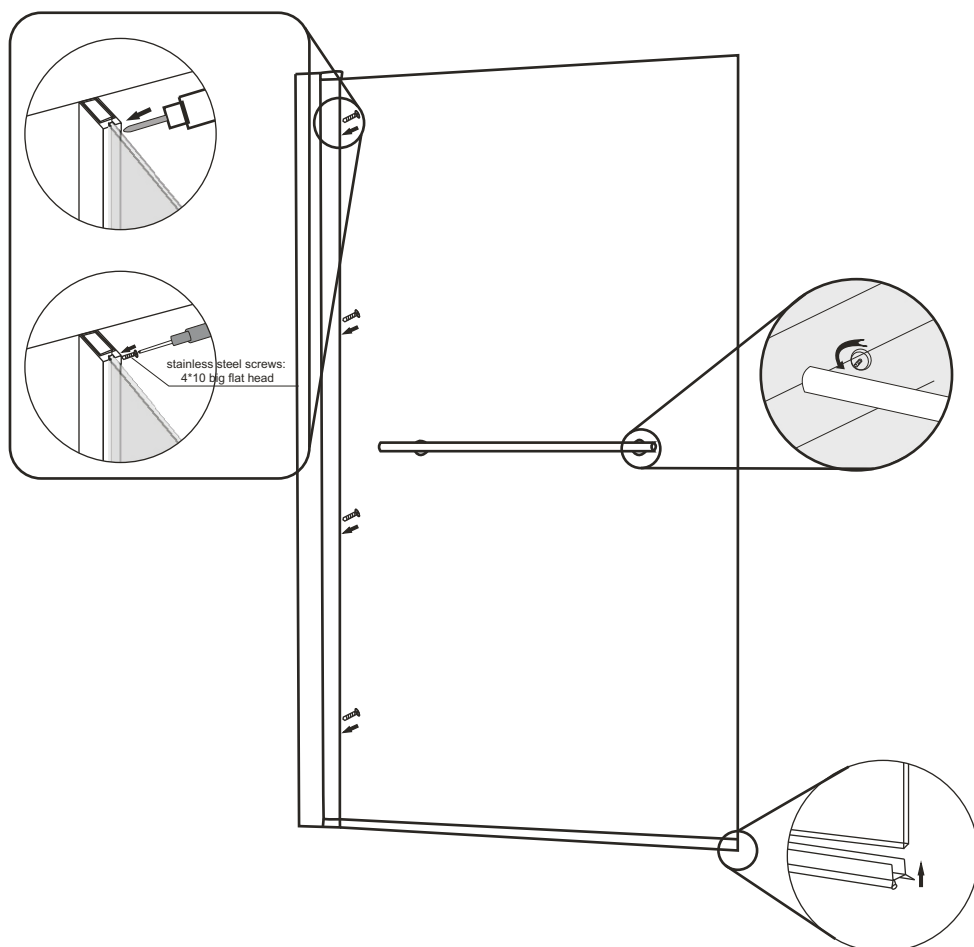

Fix the handle(C) and VERTICAL SEAL FOR FIXED GLASS (D) onto the SIDE PANEL(B).